

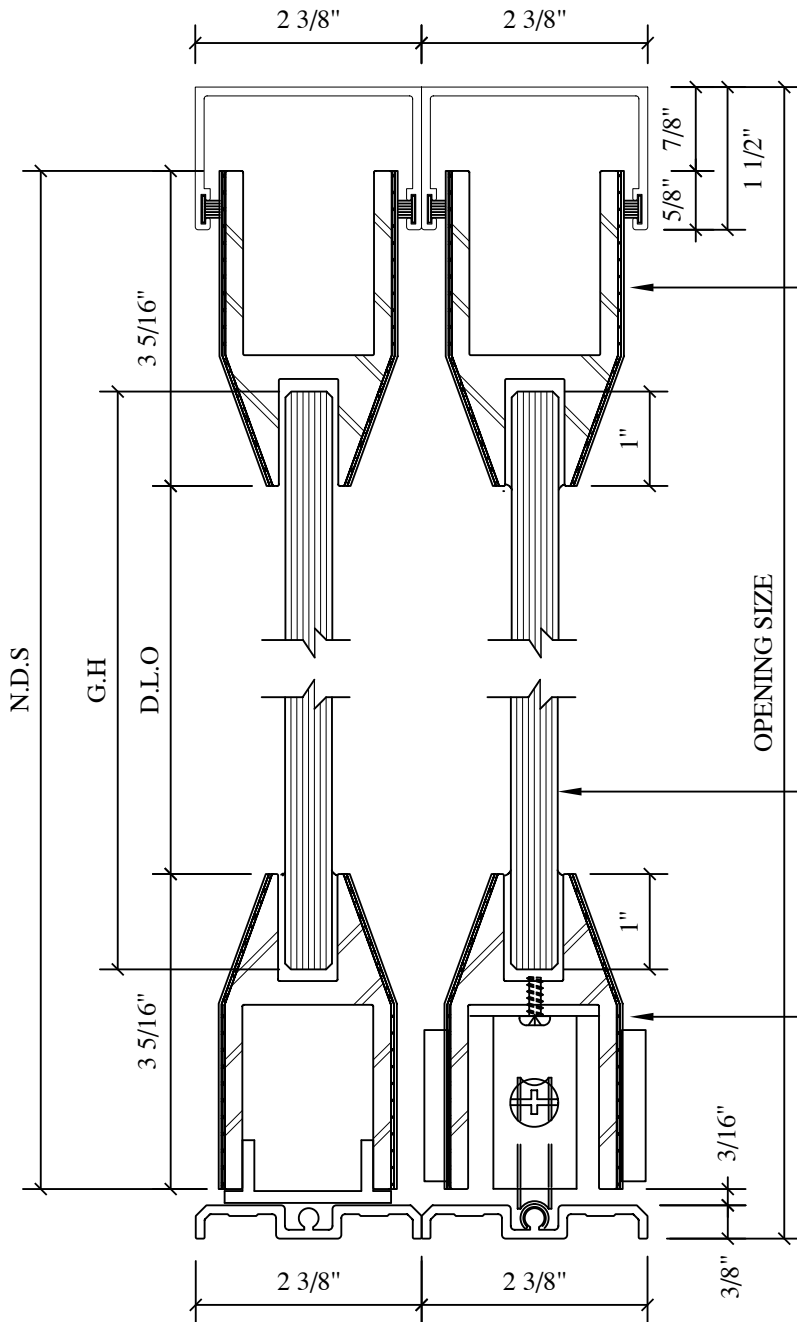

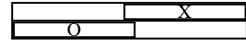

\* FINISHES AVAILABLE :  
# 8 POLISHED & # 4 SATIN STAINLESS  
US3 POLISHED & US4 SATIN BRASS ( NON LACQUER COATED)  
US10B  
ANODIZED PAINTED

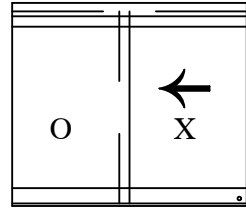

PL150 CLAD  
BY P.R.L GLASS

**GLASS HEIGHT = D.L.O + 2"**

1/2" CLEAR TEMPERED  
GLASS  
BY P.R.L GLASS

PL 150 CLAD  
BY P.R.L GLASS

\* FINISHES AVAILABLE :  
# 8 POLISHED & # 4 SATIN  
STAINLESS  
US3 POLISHED & US4 SATIN  
BRASS ( NON LACQUER COATED)  
US10B  
ANODIZED PAINTED

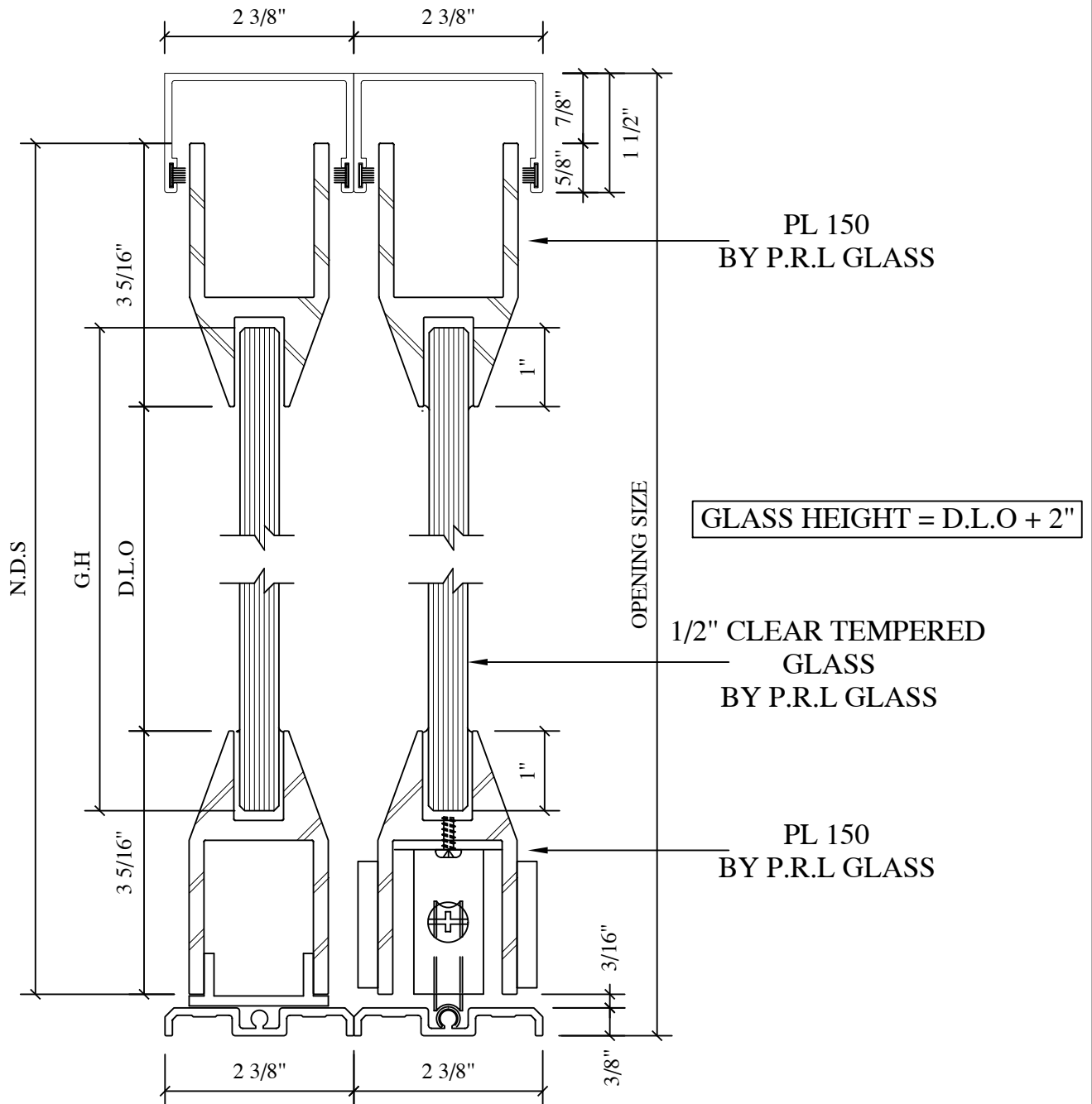
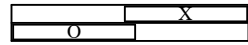
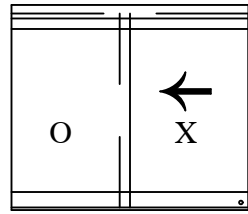

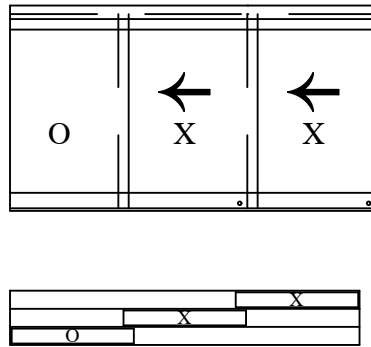

\* FINISHES AVAILABLE :  
# 8 POLISHED & # 4 SATIN  
STAINLESS  
US3 POLISHED & US4 SATIN  
BRASS ( NON LACQUER COATED)  
US10B  
ANODIZED PAINTED

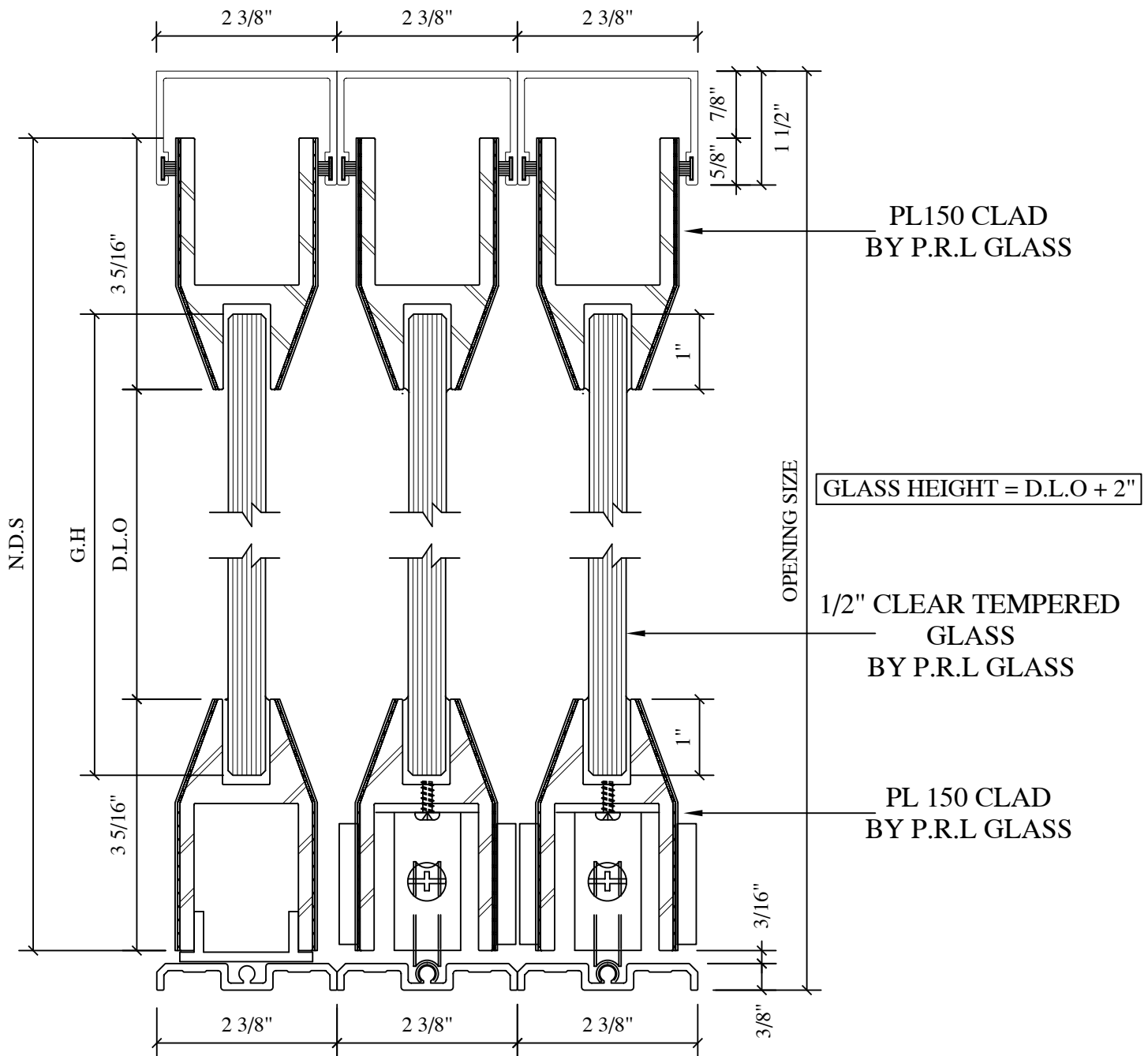

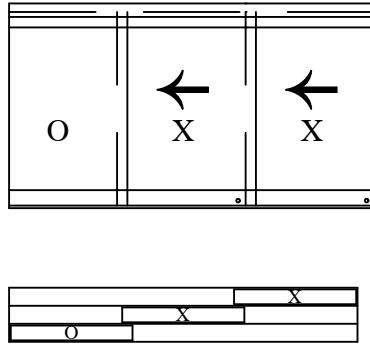

\* FINISHES AVAILABLE :  
# 8 POLISHED & # 4 SATIN  
STAINLESS  
US3 POLISHED & US4 SATIN  
BRASS ( NON LACQUER COATED)  
US10B  
ANODIZED PAINTED

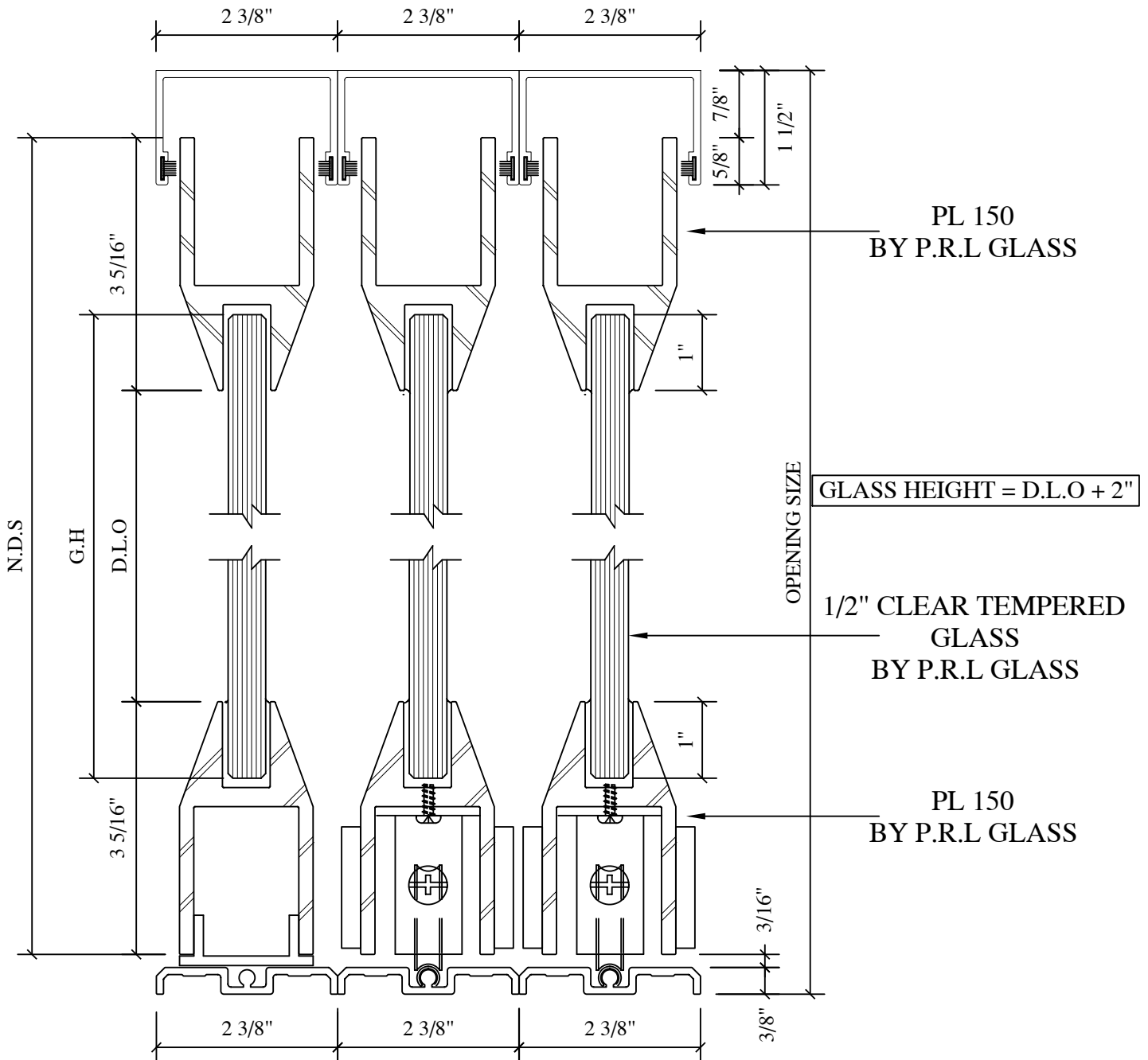

# PRL

GLASS  
SYSTEMS  
INC.  
PrIglass.com



## PL150 CLAD BTM ROLL SYSTEM (X)

DWG NO.: BOTTOM ROLLING SLIDER1

DATE: 05/22/10

\* FINISHES AVAILABLE :  
# 8 POLISHED & # 4 SATIN  
STAINLESS  
US3 POLISHED & US4 SATIN  
BRASS ( NON LACQUER COATED)  
US10B  
ANODIZED PAINTED

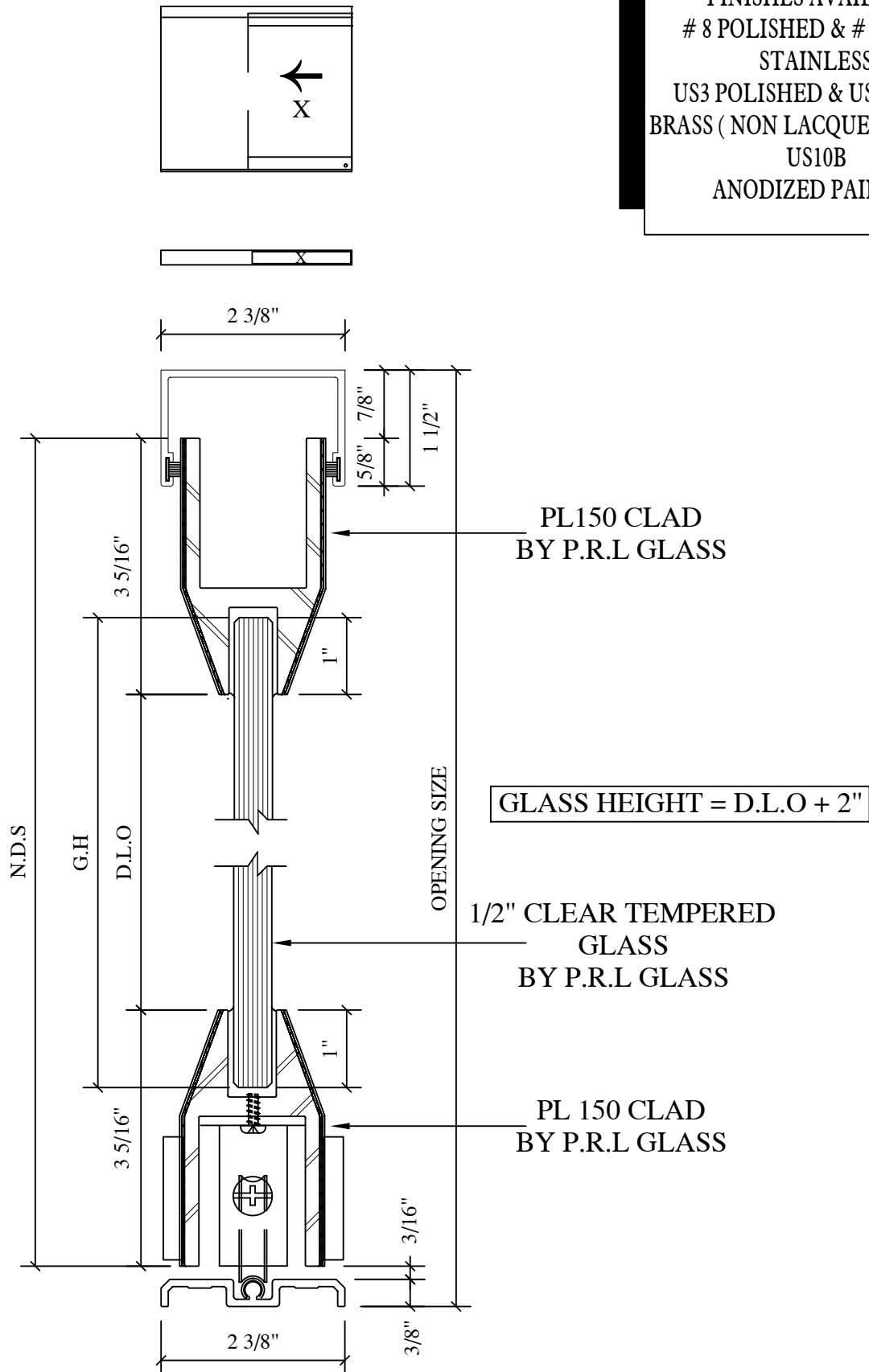

\* FINISHES AVAILABLE :  
# 8 POLISHED & # 4 SATIN  
STAINLESS  
US3 POLISHED & US4 SATIN  
BRASS ( NON LACQUER COATED)  
US10B  
ANODIZED PAINTED

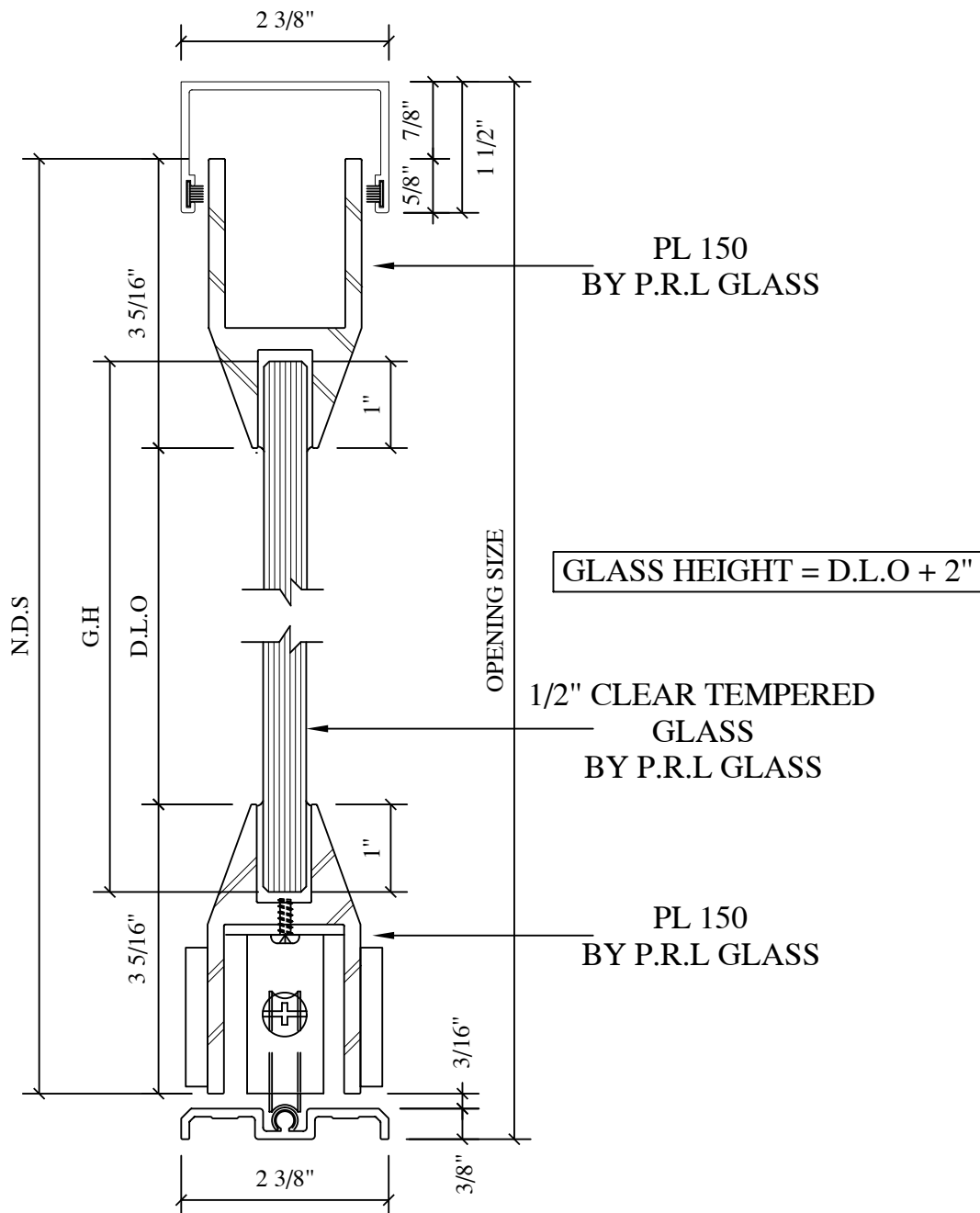
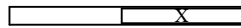
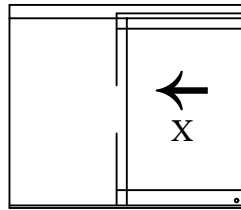





\* FINISHES AVAILABLE :  
# 8 POLISHED & # 4 SATIN  
STAINLESS  
US3 POLISHED & US4 SATIN  
BRASS ( NON LACQUER COATED)  
US10B  
ANODIZED PAINTED

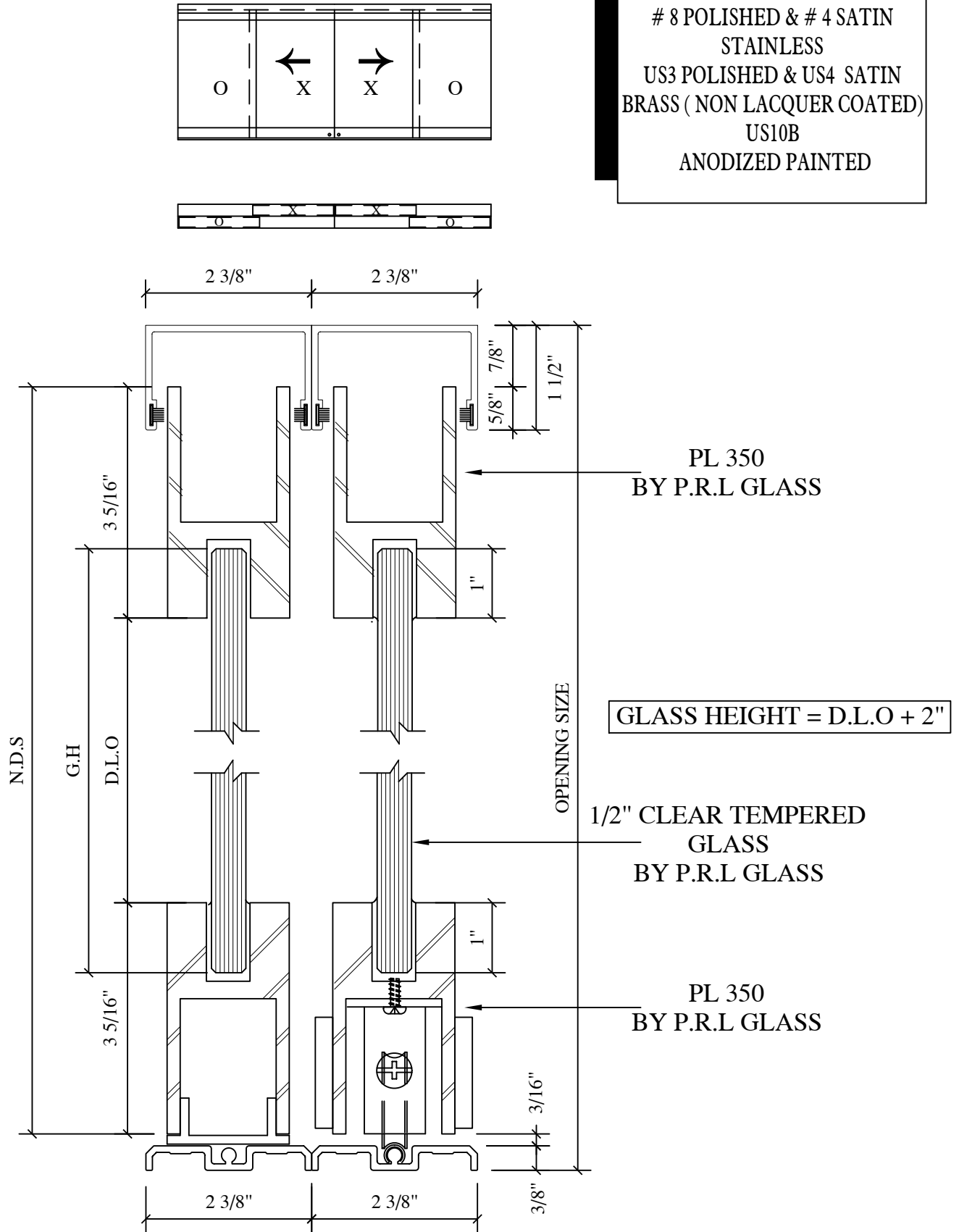

\* FINISHES AVAILABLE :  
# 8 POLISHED & # 4 SATIN  
STAINLESS  
US3 POLISHED & US4 SATIN  
BRASS ( NON LACQUER COATED)  
US10B  
ANODIZED PAINTED

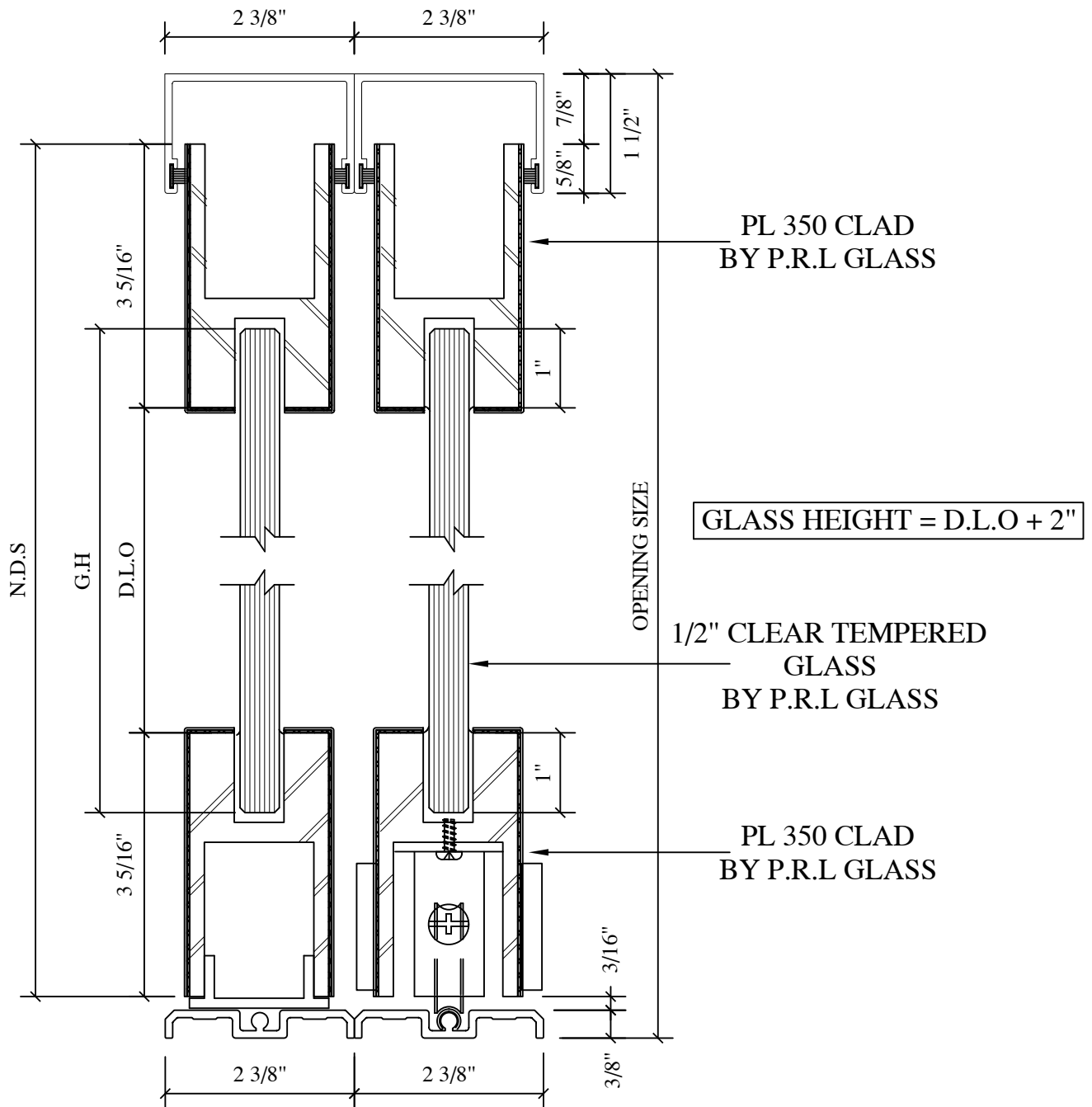
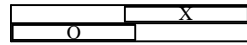
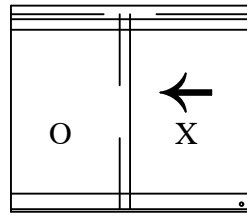

\* FINISHES AVAILABLE :  
# 8 POLISHED & # 4 SATIN  
STAINLESS  
US3 POLISHED & US4 SATIN  
BRASS ( NON LACQUER COATED)  
US10B  
ANODIZED PAINTED

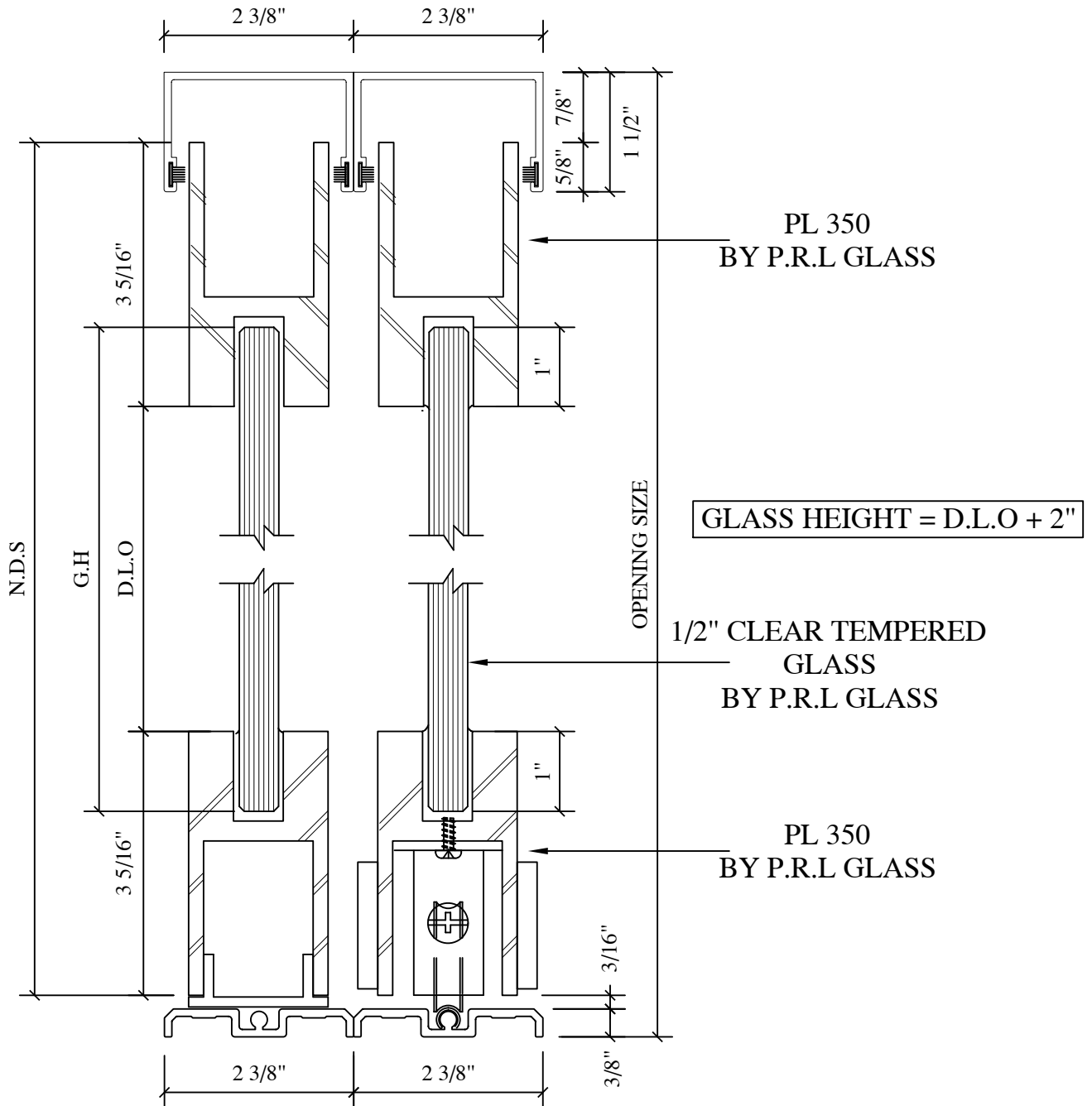
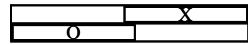
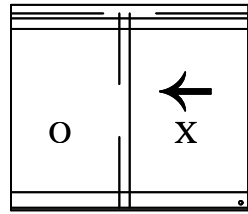

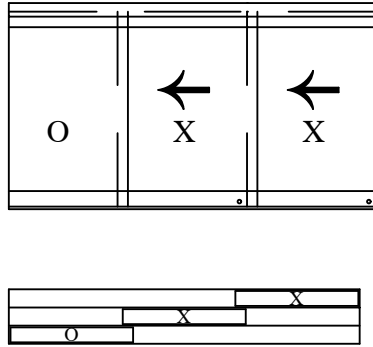

\* FINISHES AVAILABLE :  
# 8 POLISHED & # 4 SATIN  
STAINLESS  
US3 POLISHED & US4 SATIN  
BRASS ( NON LACQUER COATED)  
US10B  
ANODIZED PAINTED

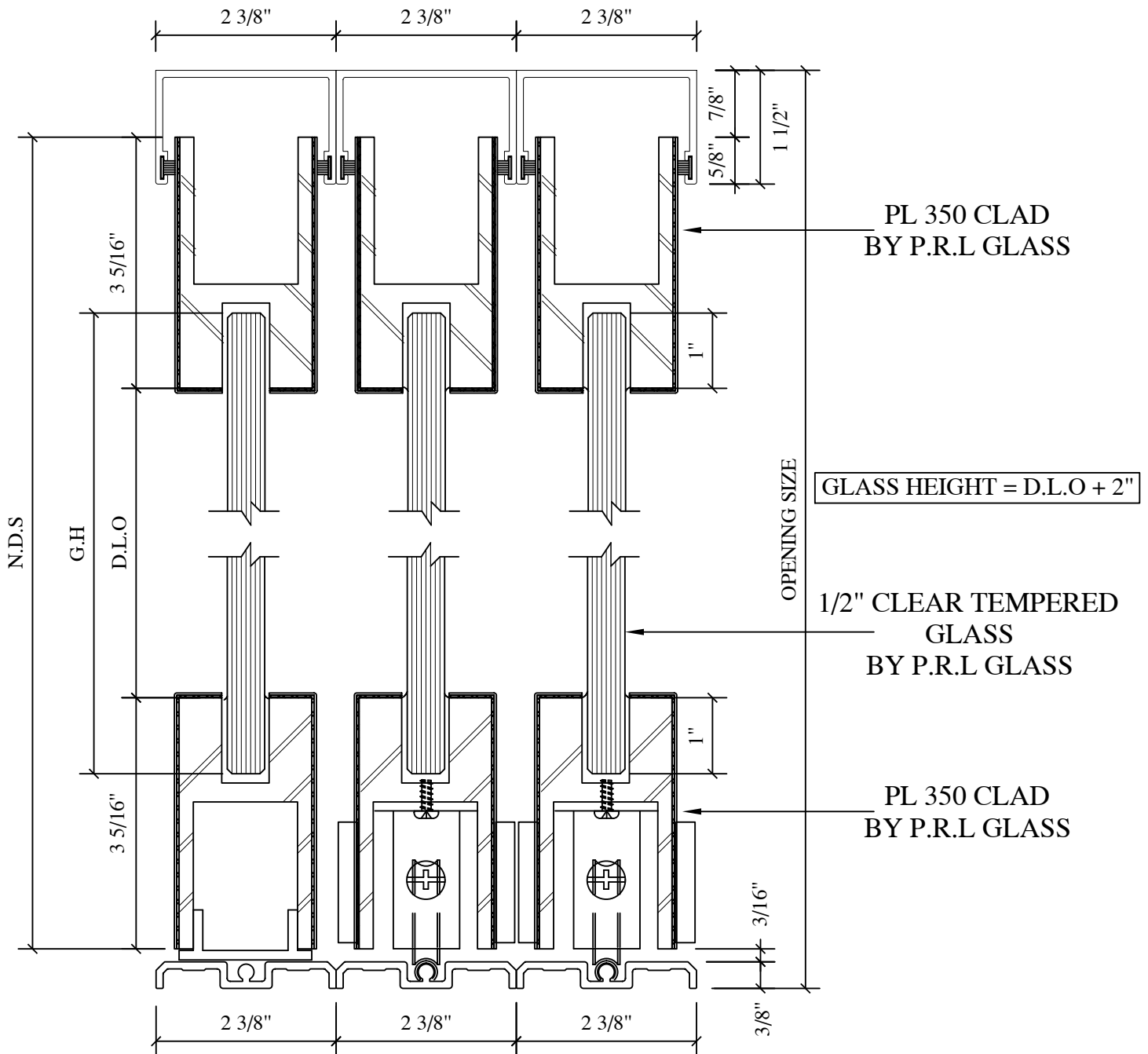

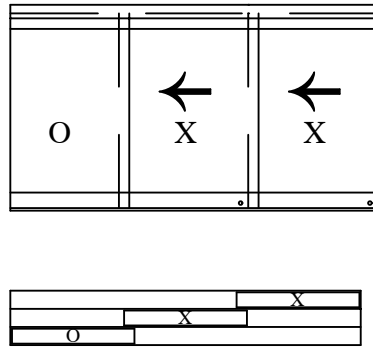

\* FINISHES AVAILABLE :  
# 8 POLISHED & # 4 SATIN  
STAINLESS  
US3 POLISHED & US4 SATIN  
BRASS ( NON LACQUER COATED)  
US10B  
ANODIZED PAINTED

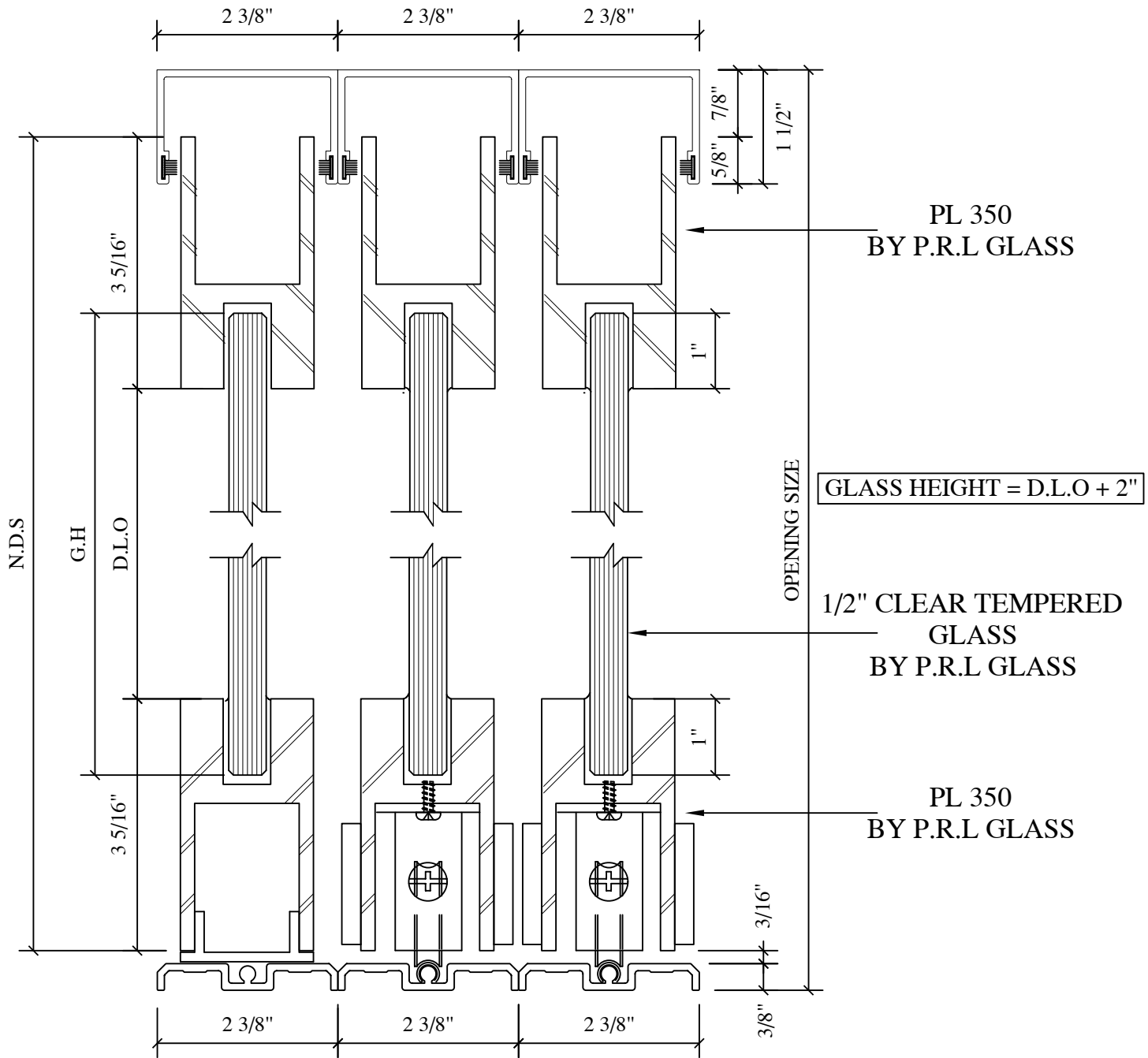

\* FINISHES AVAILABLE :  
# 8 POLISHED & # 4 SATIN  
STAINLESS  
US3 POLISHED & US4 SATIN  
BRASS ( NON LACQUER COATED)  
US10B  
ANODIZED PAINTED

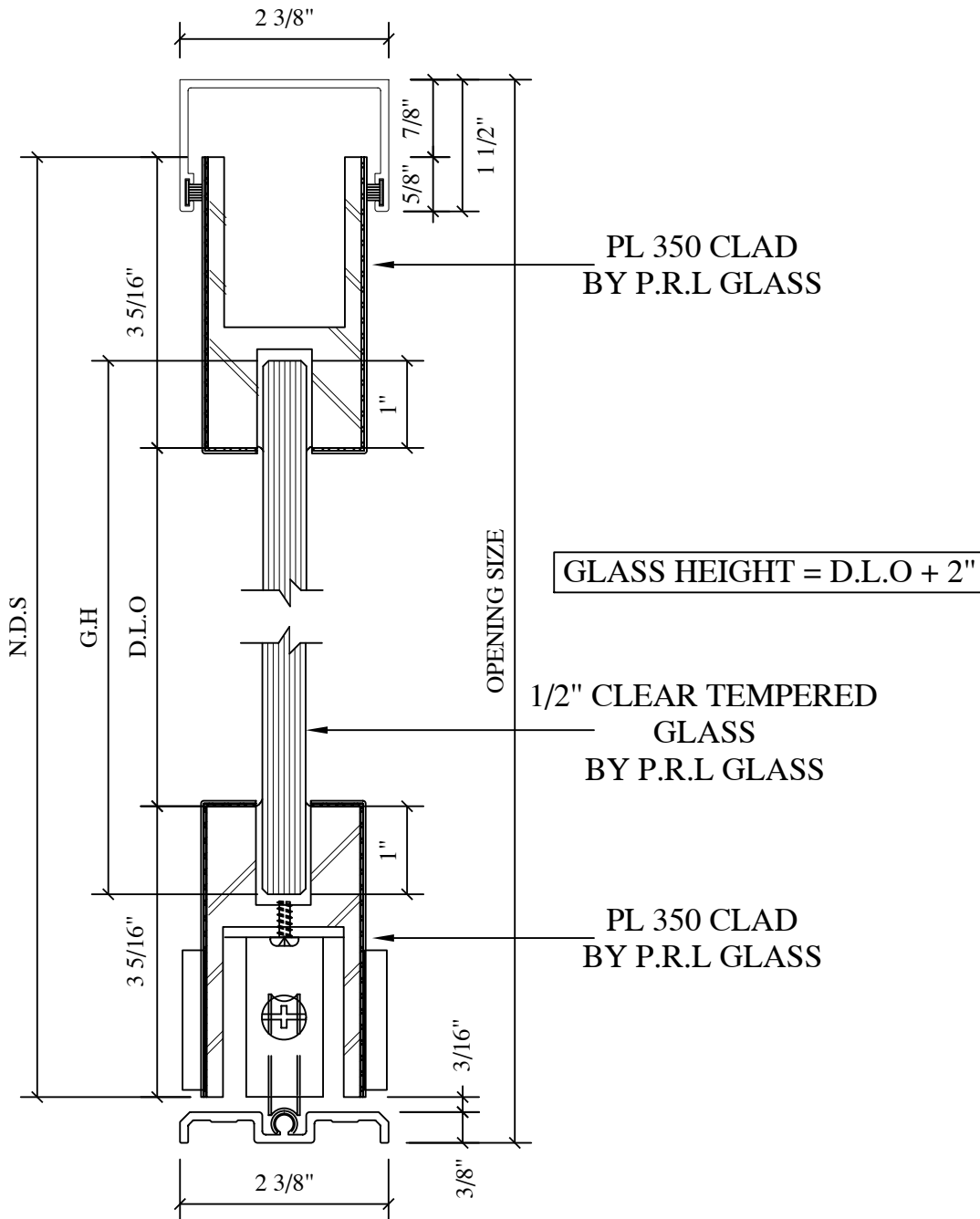
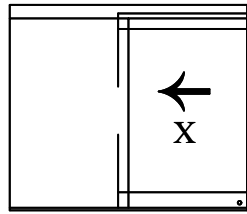

\* FINISHES AVAILABLE :  
# 8 POLISHED & # 4 SATIN  
STAINLESS  
US3 POLISHED & US4 SATIN  
BRASS ( NON LACQUER COATED)  
US10B  
ANODIZED PAINTED

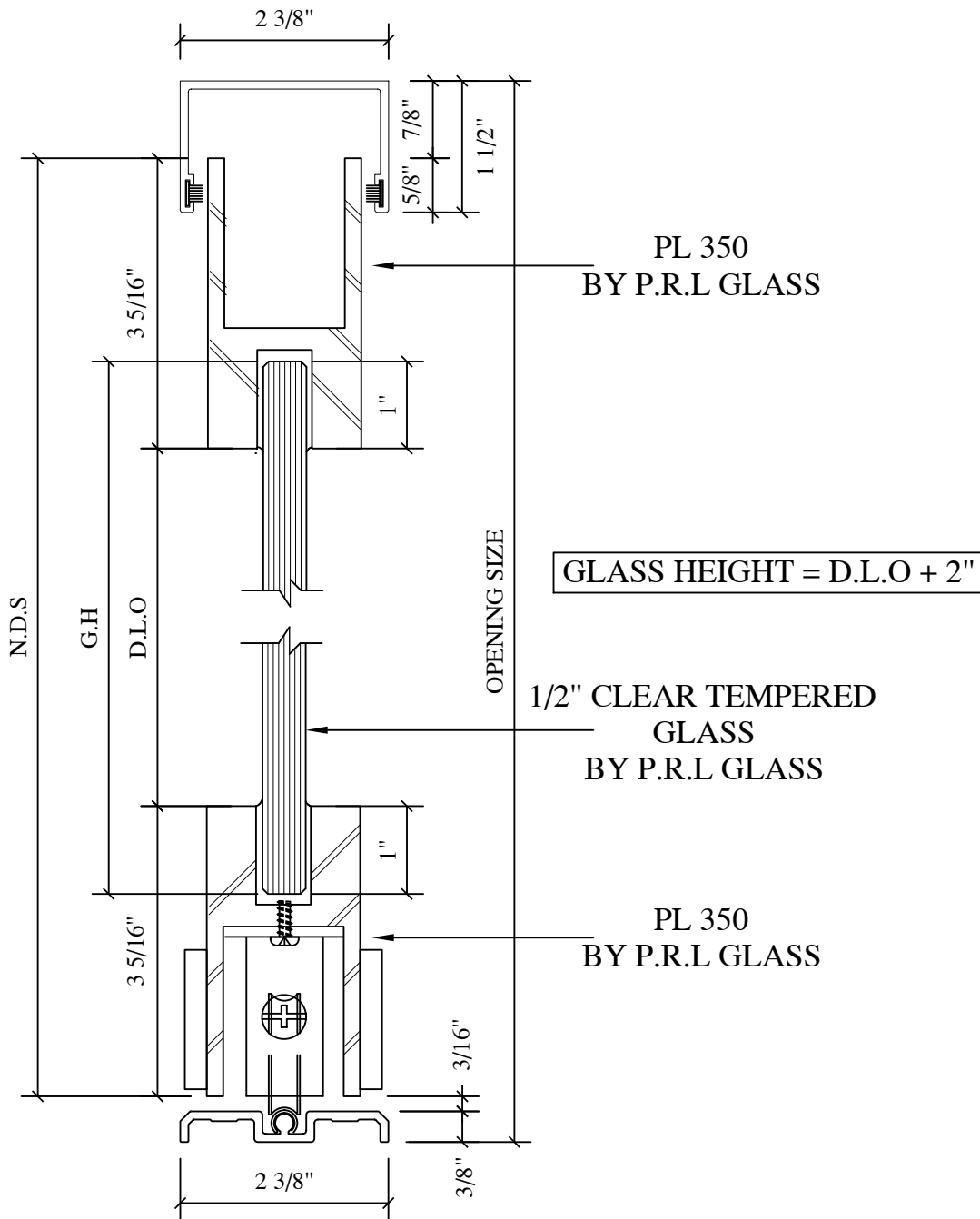
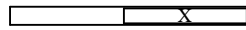
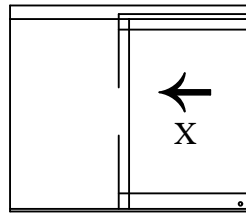





\* FINISHES AVAILABLE :  
# 8 POLISHED & # 4 SATIN  
STAINLESS  
US3 POLISHED & US4 SATIN  
BRASS ( NON LACQUER COATED)  
US10B  
ANODIZED PAINTED

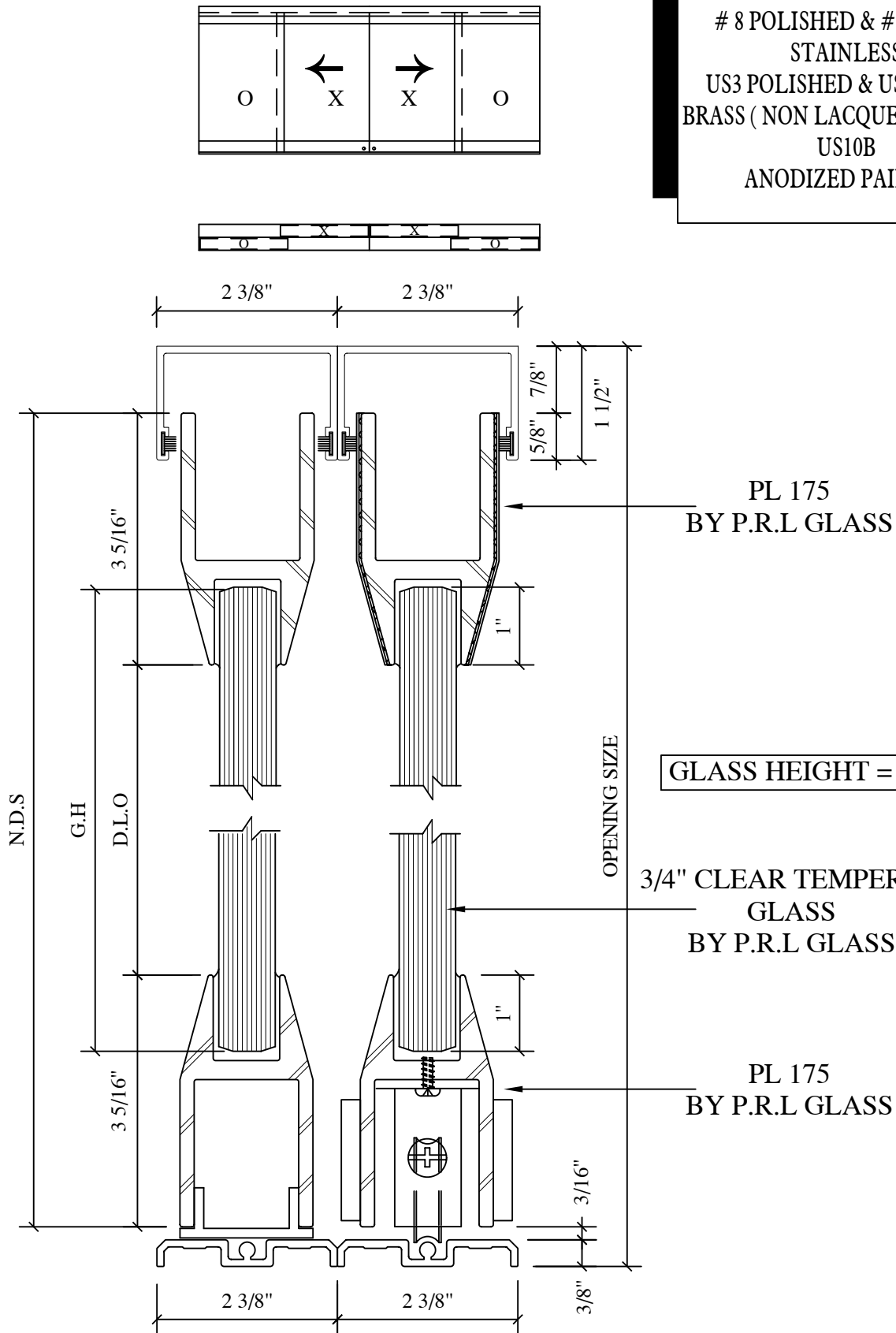

\* FINISHES AVAILABLE :  
# 8 POLISHED & # 4 SATIN  
STAINLESS  
US3 POLISHED & US4 SATIN  
BRASS ( NON LACQUER COATED)  
US10B  
ANODIZED PAINTED

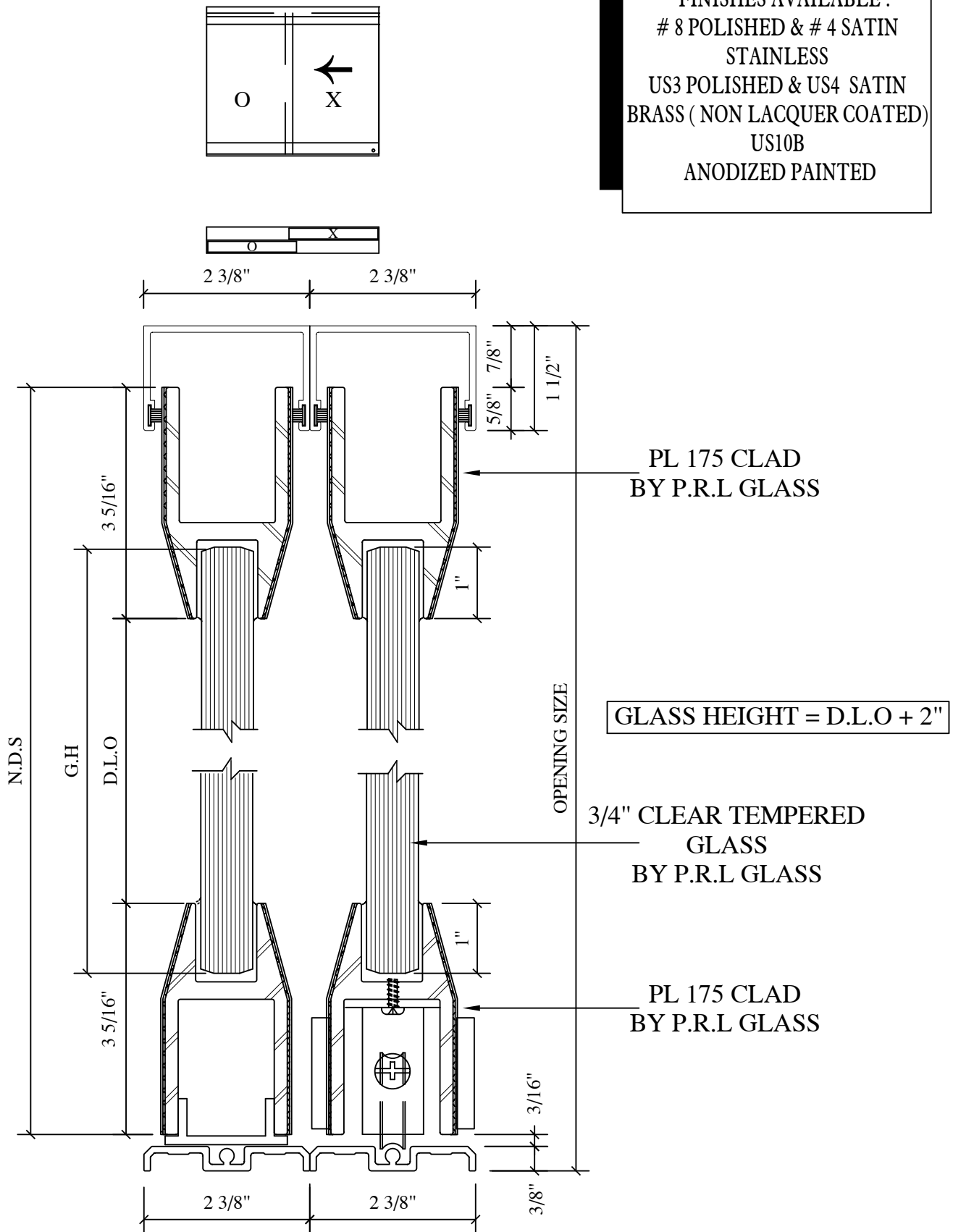

\* FINISHES AVAILABLE :  
# 8 POLISHED & # 4 SATIN  
STAINLESS  
US3 POLISHED & US4 SATIN  
BRASS ( NON LACQUER COATED)  
US10B  
ANODIZED PAINTED

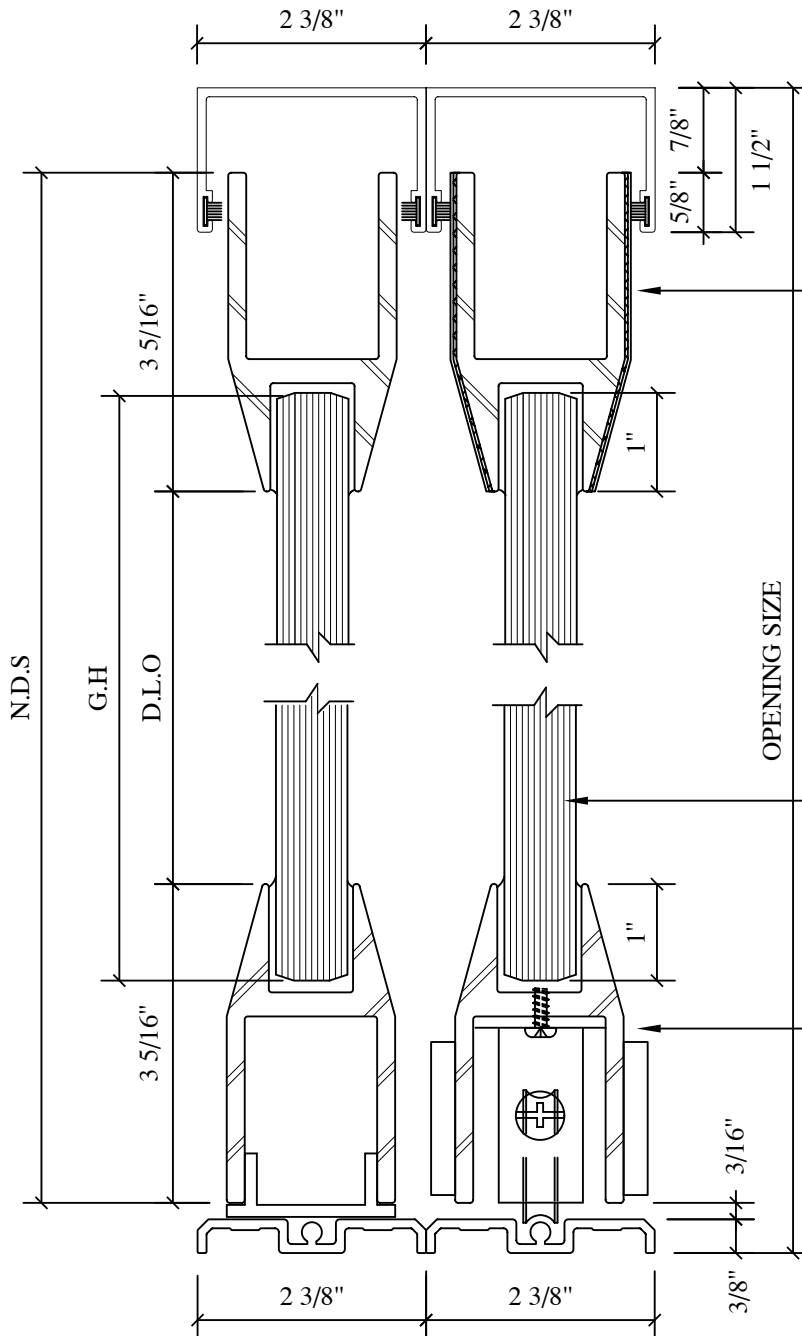
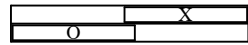
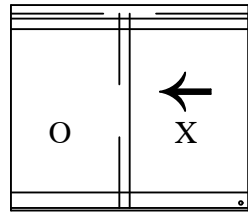

PL 175  
BY P.R.L GLASS

GLASS HEIGHT = D.L.O + 2"

3/4" CLEAR TEMPERED  
GLASS  
BY P.R.L GLASS

PL 175  
BY P.R.L GLASS

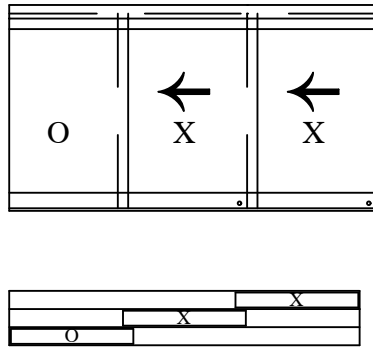

\* FINISHES AVAILABLE :  
# 8 POLISHED & # 4 SATIN  
STAINLESS  
US3 POLISHED & US4 SATIN  
BRASS ( NON LACQUER COATED)  
US10B  
ANODIZED PAINTED

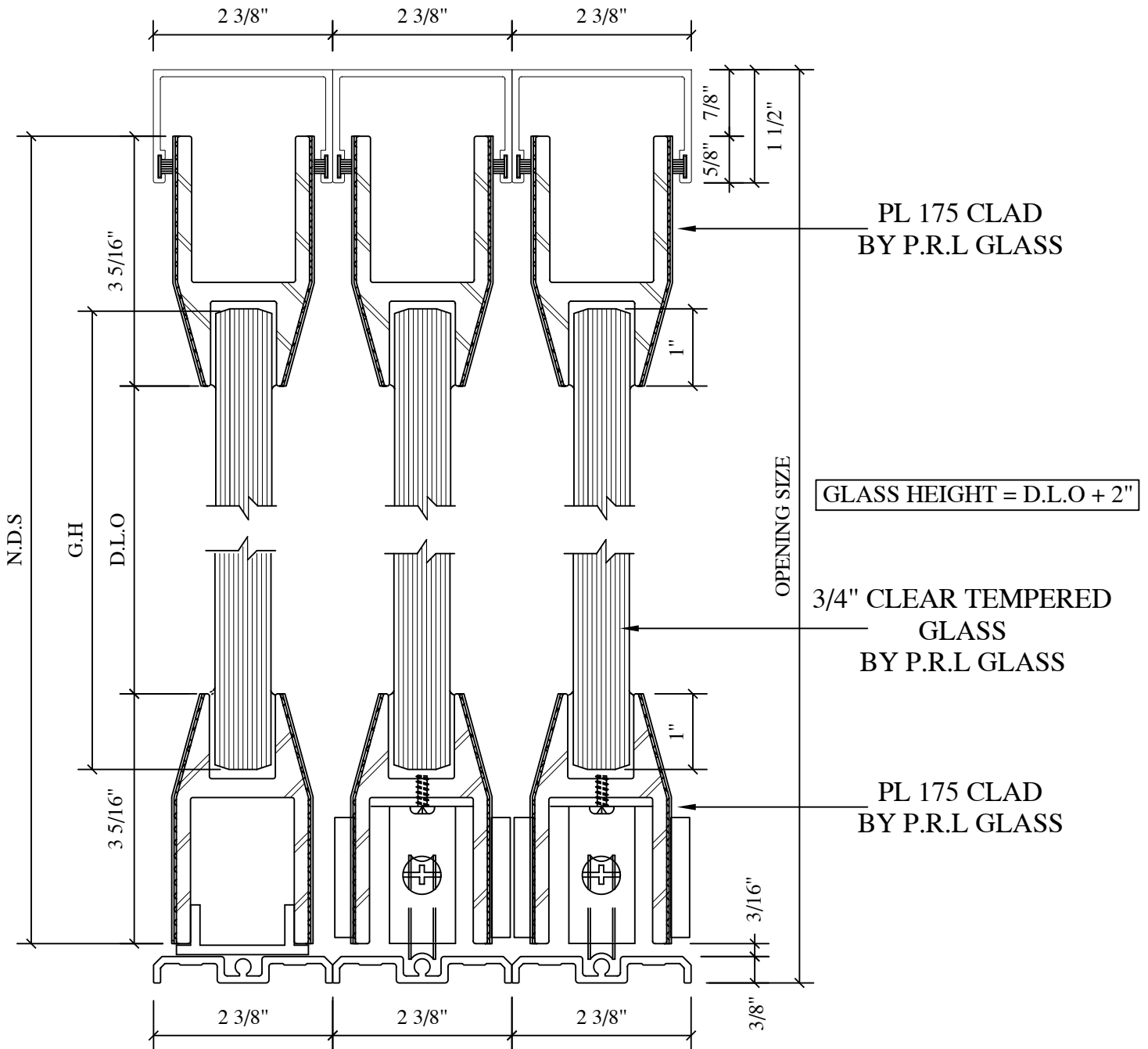

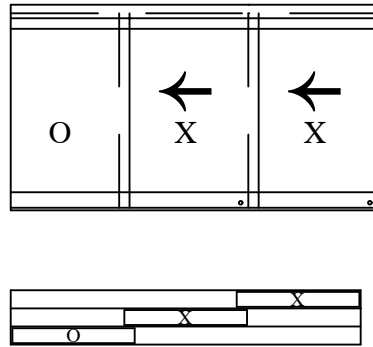

\* FINISHES AVAILABLE :  
# 8 POLISHED & # 4 SATIN  
STAINLESS  
US3 POLISHED & US4 SATIN  
BRASS ( NON LACQUER COATED)  
US10B  
ANODIZED PAINTED

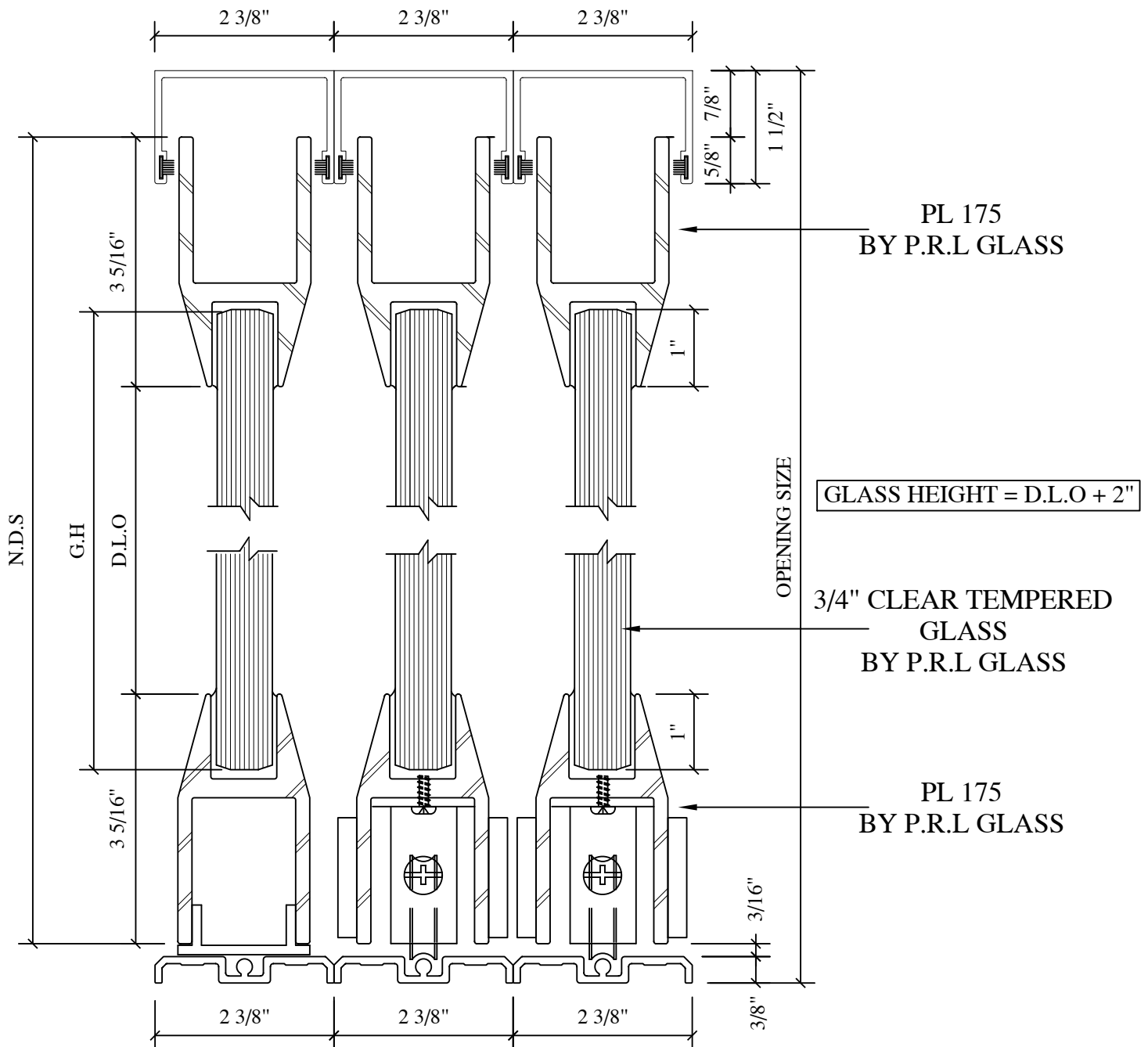



\* FINISHES AVAILABLE :  
# 8 POLISHED & # 4 SATIN  
STAINLESS  
US3 POLISHED & US4 SATIN  
BRASS ( NON LACQUER COATED)  
US10B  
ANODIZED PAINTED

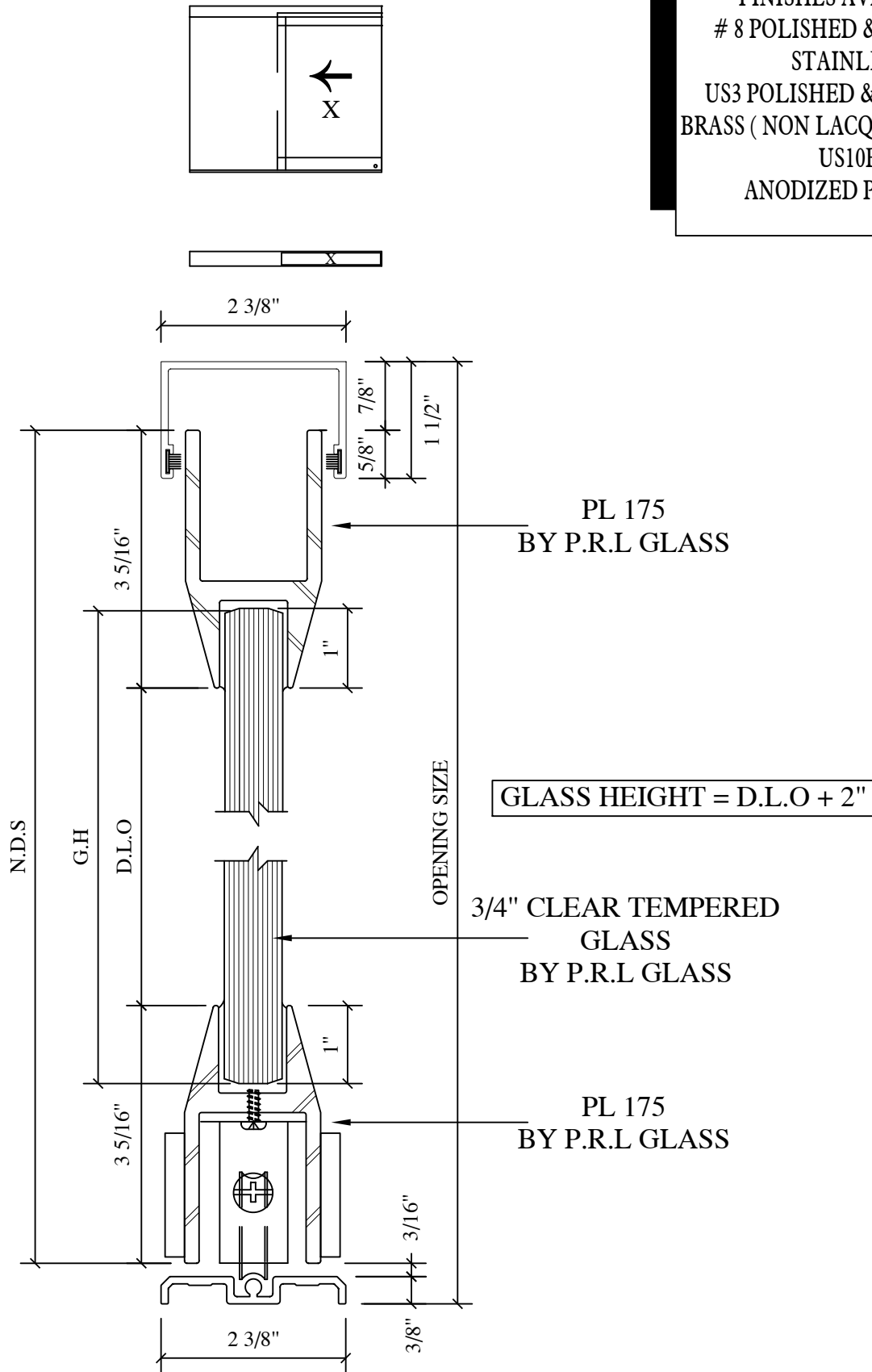



\* FINISHES AVAILABLE :  
# 8 POLISHED & # 4 SATIN  
STAINLESS  
US3 POLISHED & US4 SATIN  
BRASS ( NON LACQUER COATED)  
US10B  
ANODIZED PAINTED

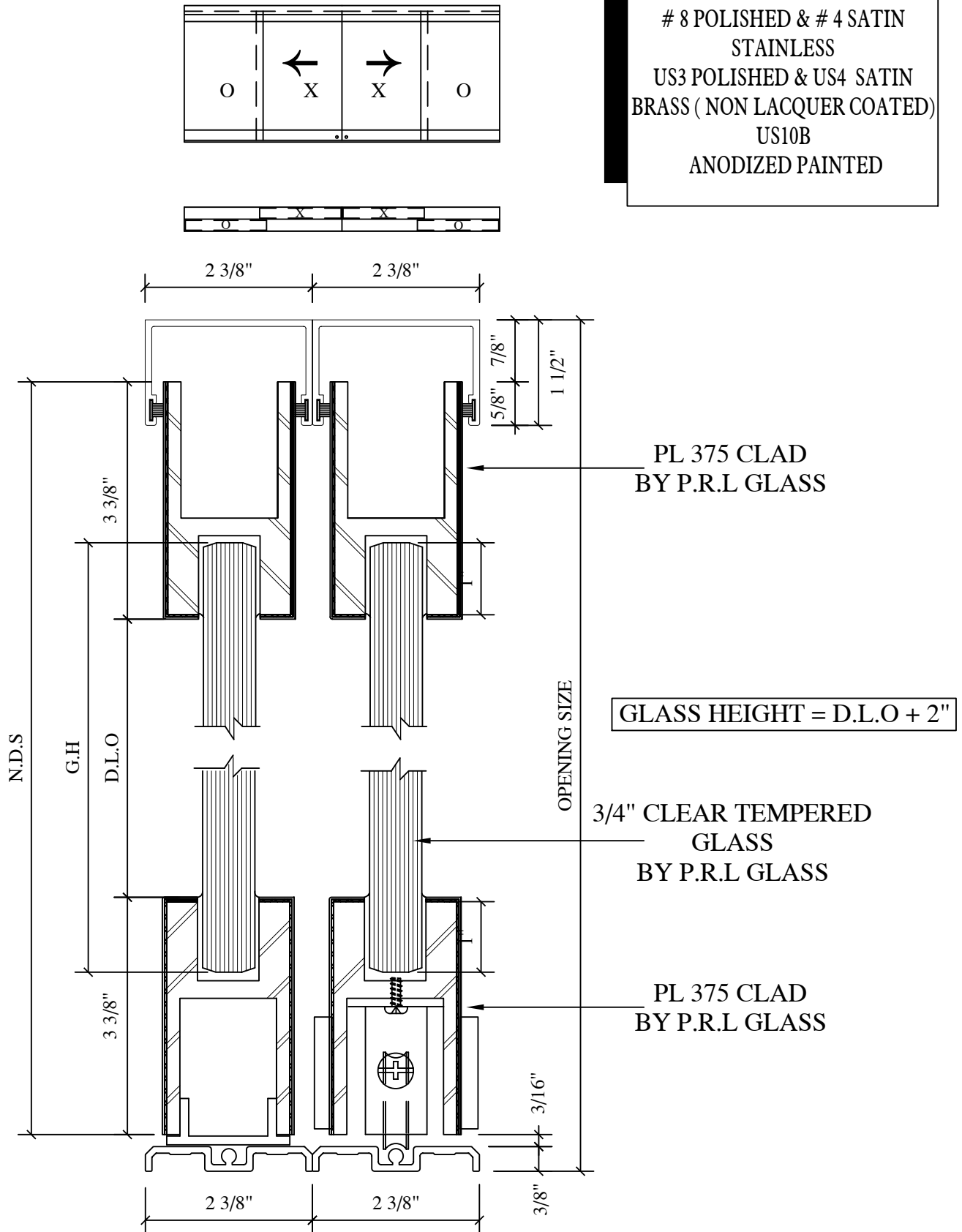

\* FINISHES AVAILABLE :  
# 8 POLISHED & # 4 SATIN  
STAINLESS  
US3 POLISHED & US4 SATIN  
BRASS ( NON LACQUER COATED)  
US10B  
ANODIZED PAINTED

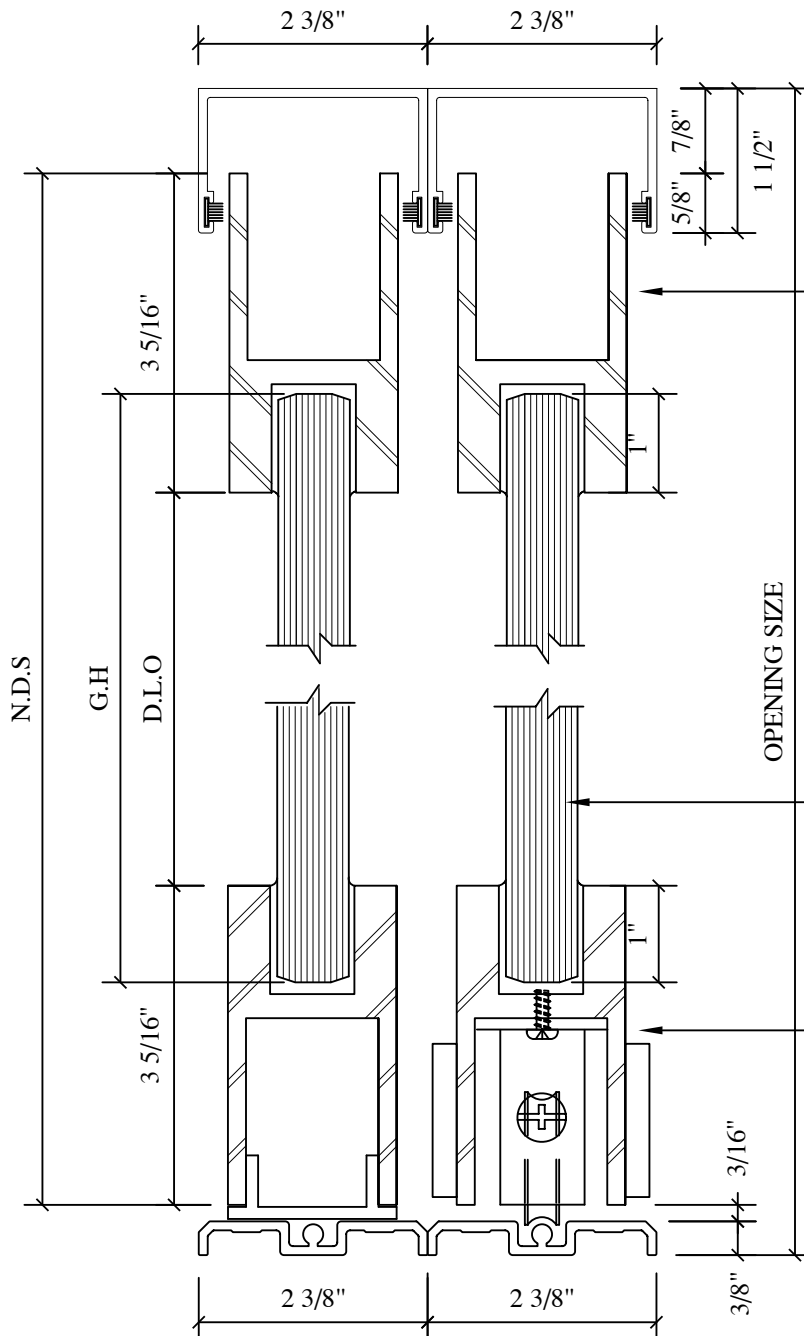
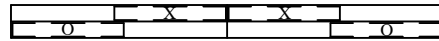
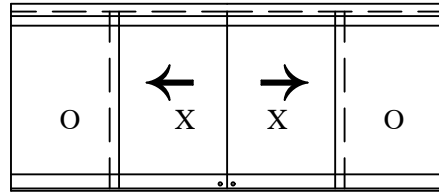

PL 375  
BY P.R.L GLASS

GLASS HEIGHT = D.L.O + 2"

3/4" CLEAR TEMPERED  
GLASS  
BY P.R.L GLASS

PL 375  
BY P.R.L GLASS

# PRL

GLASS  
SYSTEMS  
INC.

Prlglass.com



## PL375 CLAD BTM ROLL SYSTEM (O,X)

DWG NO.: BOTTOM ROLLING SLIDER1

DATE: 05/22/10

\* FINISHES AVAILABLE :  
# 8 POLISHED & # 4 SATIN  
STAINLESS  
US3 POLISHED & US4 SATIN  
BRASS ( NON LACQUER COATED )  
US10B  
ANODIZED PAINTED

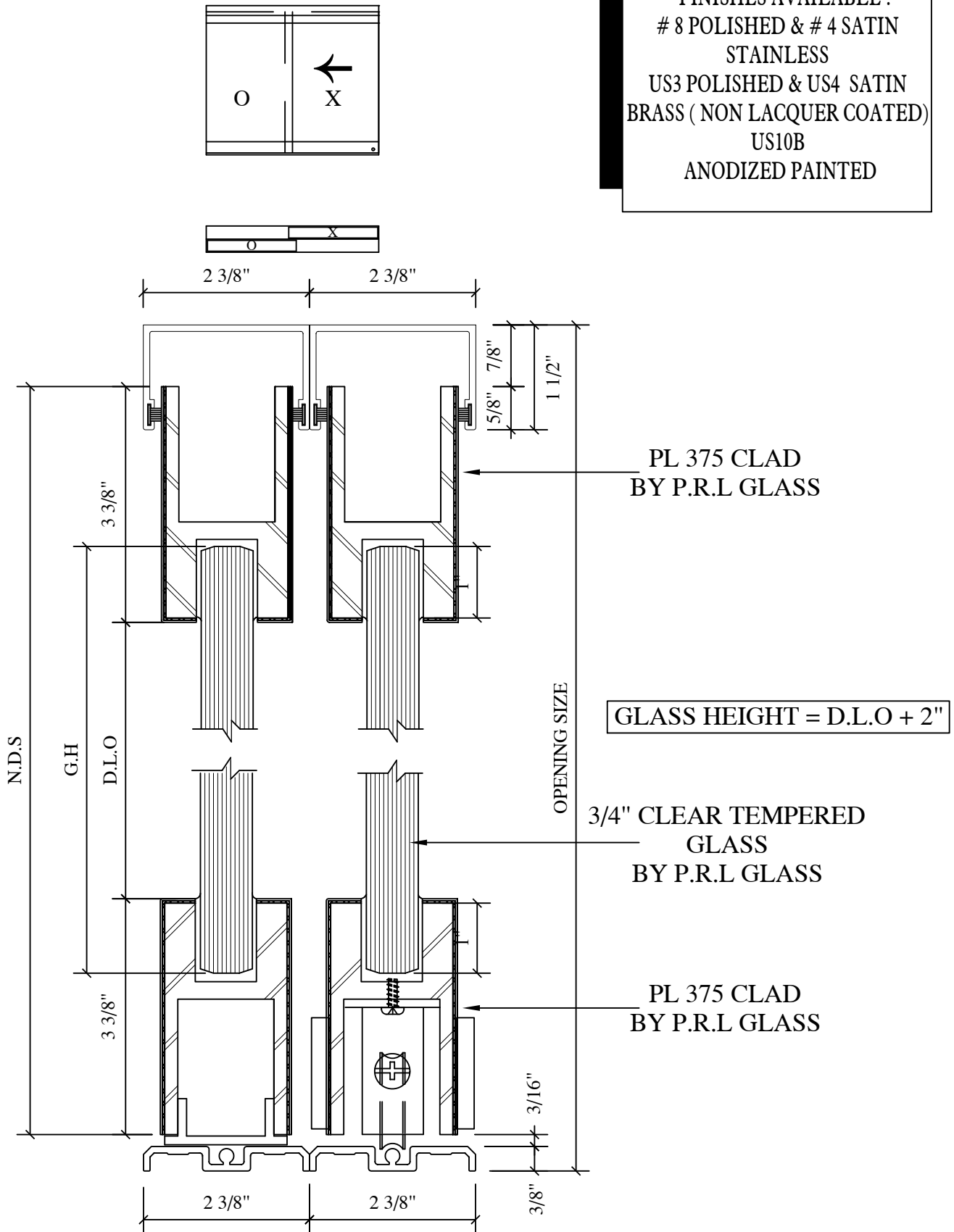

\* FINISHES AVAILABLE :  
# 8 POLISHED & # 4 SATIN  
STAINLESS  
US3 POLISHED & US4 SATIN  
BRASS ( NON LACQUER COATED)  
US10B  
ANODIZED PAINTED

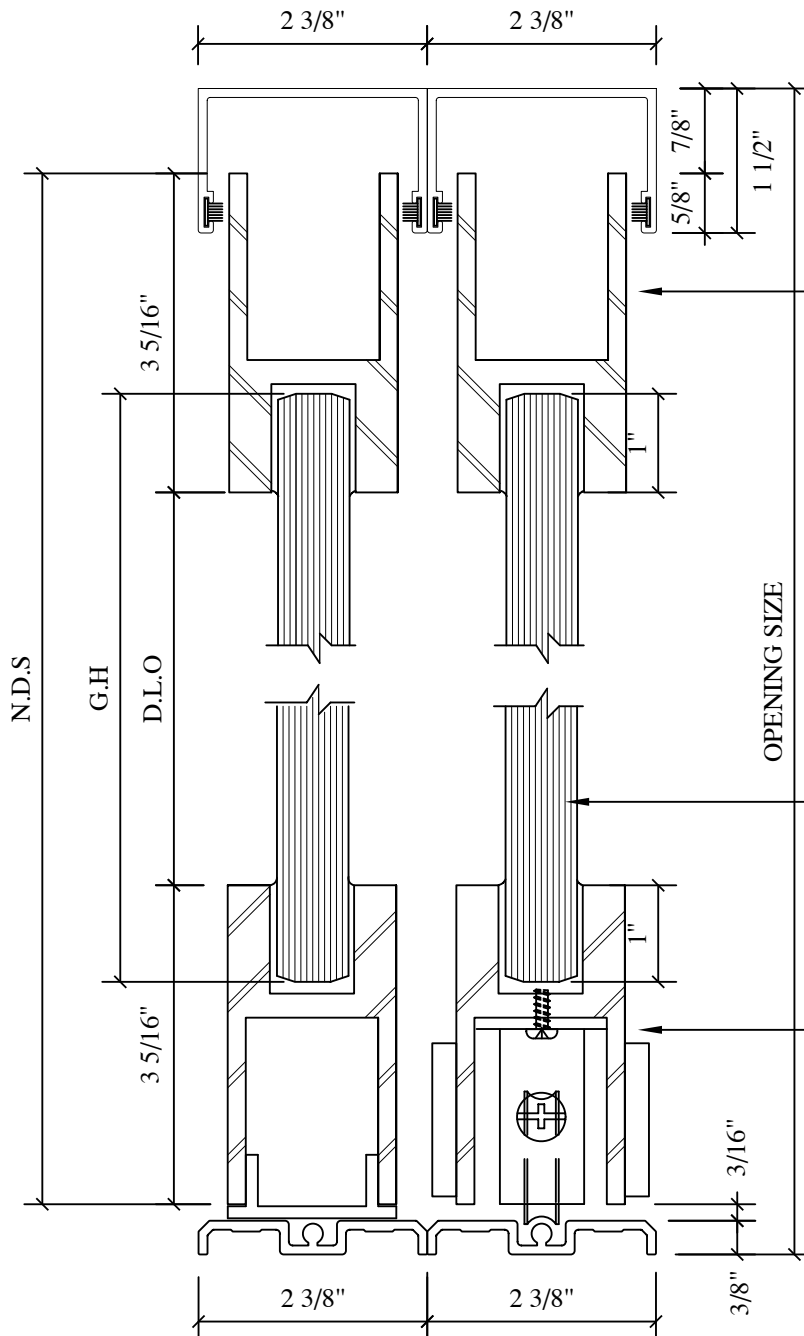
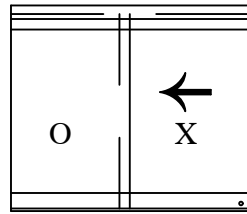

PL 375  
BY P.R.L GLASS

GLASS HEIGHT = D.L.O + 2"

3/4" CLEAR TEMPERED  
GLASS  
BY P.R.L GLASS

PL 375  
BY P.R.L GLASS

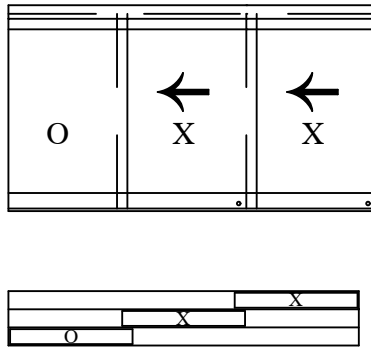

\* FINISHES AVAILABLE :  
# 8 POLISHED & # 4 SATIN  
STAINLESS  
US3 POLISHED & US4 SATIN  
BRASS ( NON LACQUER COATED )  
US10B  
ANODIZED PAINTED

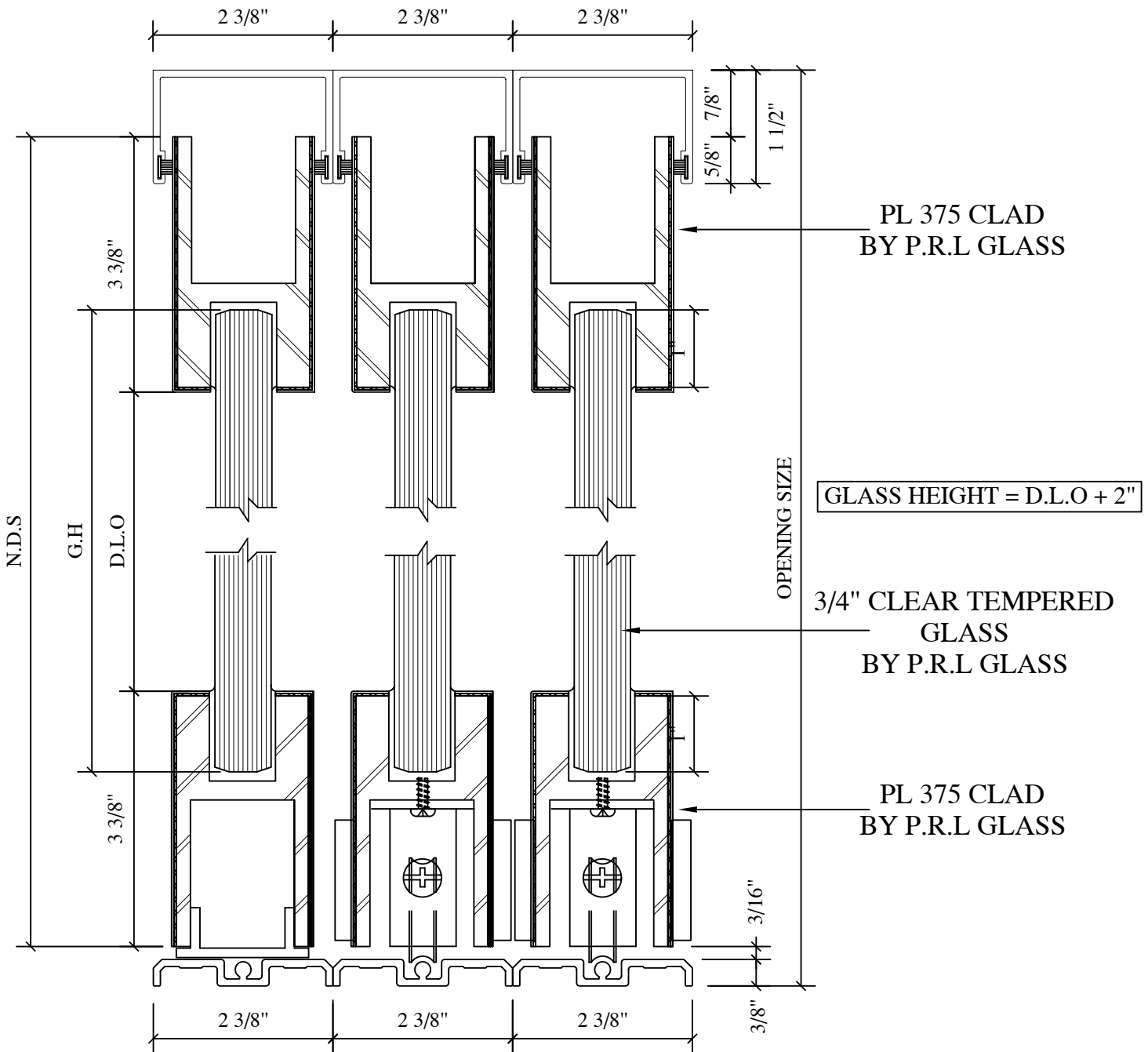

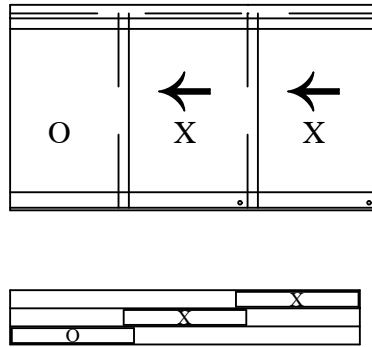

\* FINISHES AVAILABLE :  
# 8 POLISHED & # 4 SATIN  
STAINLESS  
US3 POLISHED & US4 SATIN  
BRASS ( NON LACQUER COATED)  
US10B  
ANODIZED PAINTED

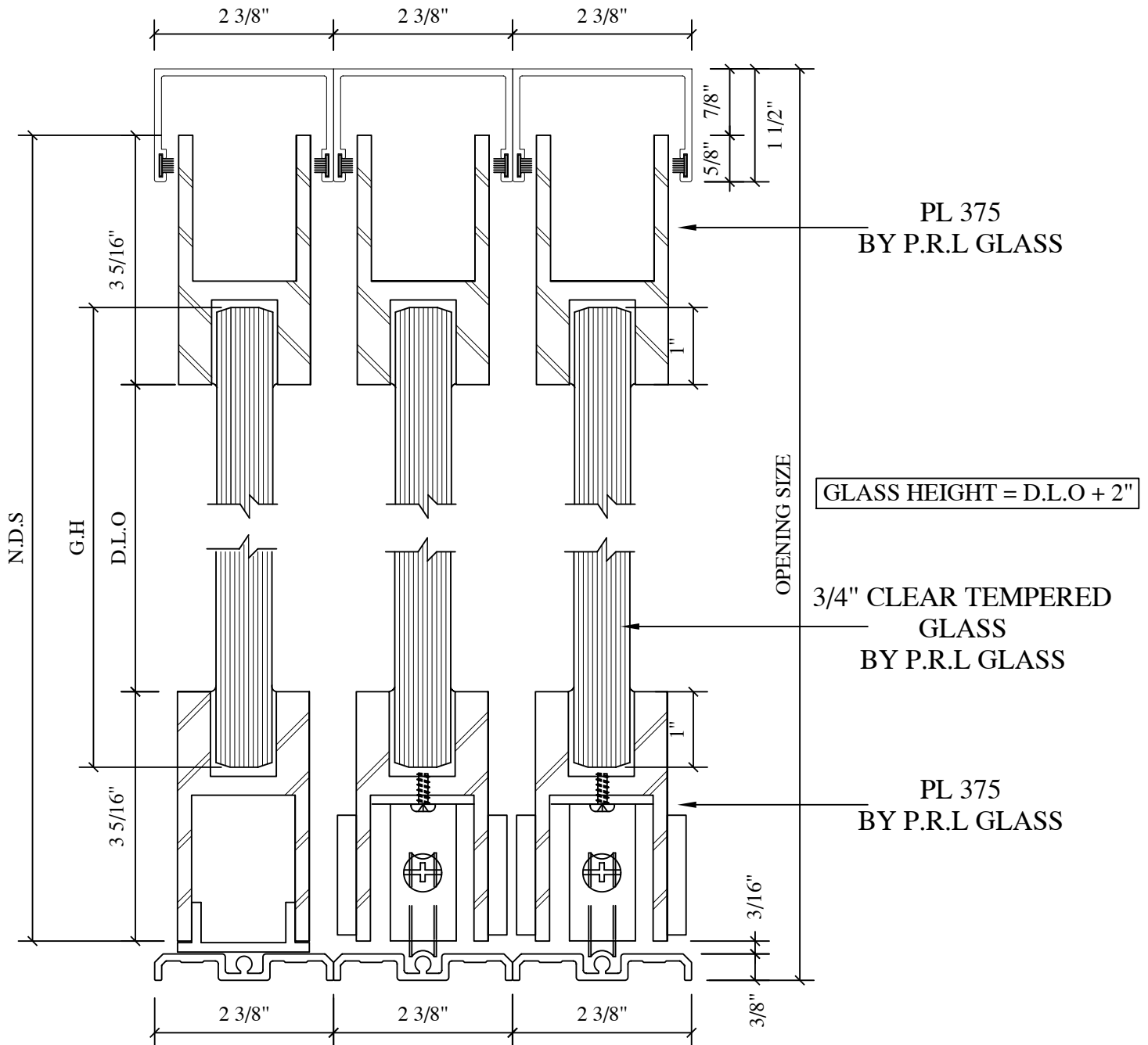

\* FINISHES AVAILABLE :  
# 8 POLISHED & # 4 SATIN  
STAINLESS  
US3 POLISHED & US4 SATIN  
BRASS ( NON LACQUER COATED)  
US10B  
ANODIZED PAINTED

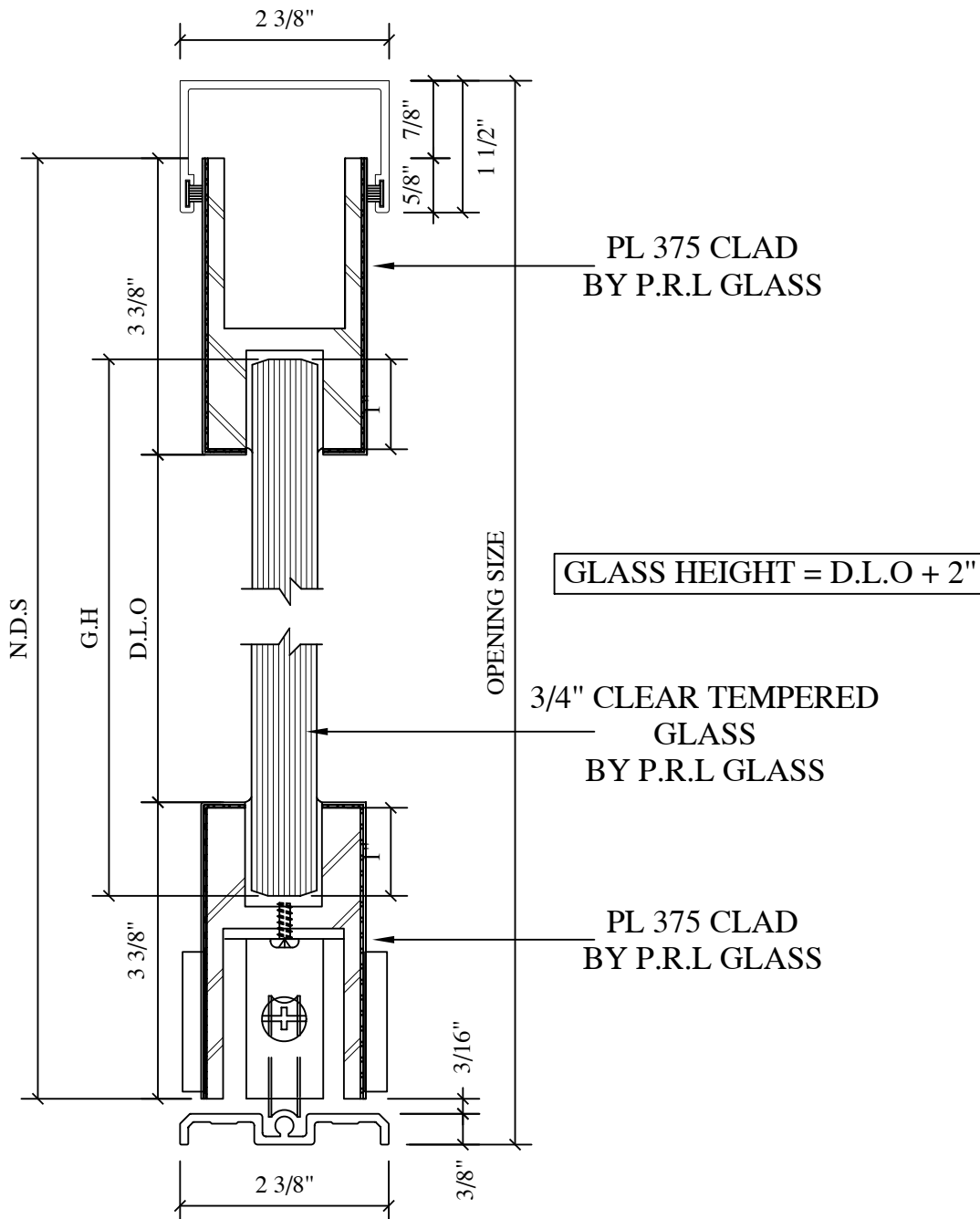
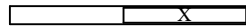
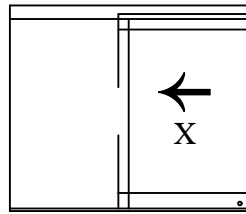

\* FINISHES AVAILABLE :  
# 8 POLISHED & # 4 SATIN  
STAINLESS  
US3 POLISHED & US4 SATIN  
BRASS ( NON LACQUER COATED)  
US10B  
ANODIZED PAINTED

